

DATA SHEET

FBL2040

3.3V BTL8-bit TTL to BTL transceiver

Product specification
IC23 Data Handbook

1998 Dec 07

3.3V BTL 8-bit TTL to BTL transceiver

FBL2040

FEATURES

- 3.3V version of FB2040A with 70% power savings
- 8-bit BTL transceivers
- Separate I/O on TTL A-port
- Inverting
- Drives heavily loaded backplanes with equivalent load impedances down to 10Ω.
- High drive 100mA BTL open collector drivers on B-port
- Allows incident wave switching in heavily loaded backplane buses
- Reduced BTL voltage swing produces less noise and reduces power consumption
- Built-in precision band-gap reference provides accurate receiver thresholds and improved noise immunity
- Compatible with IEEE Futurebus+ or proprietary BTL backplanes
- Controlled output ramp and multiple GND pins minimize ground bounce
- Each BTL driver has a dedicated Bus GND for a signal return
- Glitch-free power up/power down operation
- Low I_{CC} current
- Tight output skew
- Supports live insertion
- Pins for the optional JTAG boundary scan function are provided
- High density packaging in plastic Quad Flat Pack

QUICK REFERENCE DATA

SYMBOL	PARAMETER	TYPICAL	UNIT
t_{PLH} t_{PHL}	Propagation delay AIn to \overline{Bn}	4.4 3.1	ns
t_{PLH} t_{PHL}	Propagation delay \overline{Bn} to AOn	3.4 3.2	ns
C_{OB}	Output capacitance ($\overline{B0} - \overline{B7}$ only)	4	pF
I_{OL}	Output current ($\overline{B0} - \overline{B7}$ only)	100	mA
I_{CC}	Supply current	Standby	4
		AIn to \overline{Bn} (outputs Low)	8
		\overline{Bn} to AOn (outputs Low)	18
		AIn to \overline{Bn} (outputs High)	13
		\overline{Bn} to AOn (outputs High)	16

ORDERING INFORMATION

PACKAGES	COMMERCIAL RANGE $V_{CC} = 3V \pm 10\%$; $T_{amb} = -40^{\circ}C$ to $+85^{\circ}C$	DRAWING NUMBER
52-pin Plastic Quad Flat Pack (QFP)	FBL2040BB	SOT379-1

ABSOLUTE MAXIMUM RATINGS

Operation beyond the limits set forth in this table may impair the useful life of the device. Unless otherwise noted these limits are over the operating free-air temperature range.

SYMBOL	PARAMETER	RATING	UNIT
V_{CC}	Supply voltage	-0.5 to +4.6	V
V_{IN}	Input voltage	A10 – A17, OE $\overline{B0}$, $\overline{OE}B1$, OEA	-0.5 to +7.0
		$\overline{B0} - \overline{B7}$	-0.5 to +3.5
I_{IN}	Input current	-18 to +5.0	mA
V_{OUT}	Voltage applied to output in High output state	-0.5 to +7.0	V
I_{OUT}	Current applied to output in Low output state	A0 – A7	64, -64
		$\overline{B0} - \overline{B7}$	200
T_{amb}	Operating free-air temperature range	-40 to +85	$^{\circ}C$
T_{STG}	Storage temperature	-65 to +150	$^{\circ}C$

3.3V BTL 8-bit TTL to BTL transceiver

FBL2040

PIN CONFIGURATION

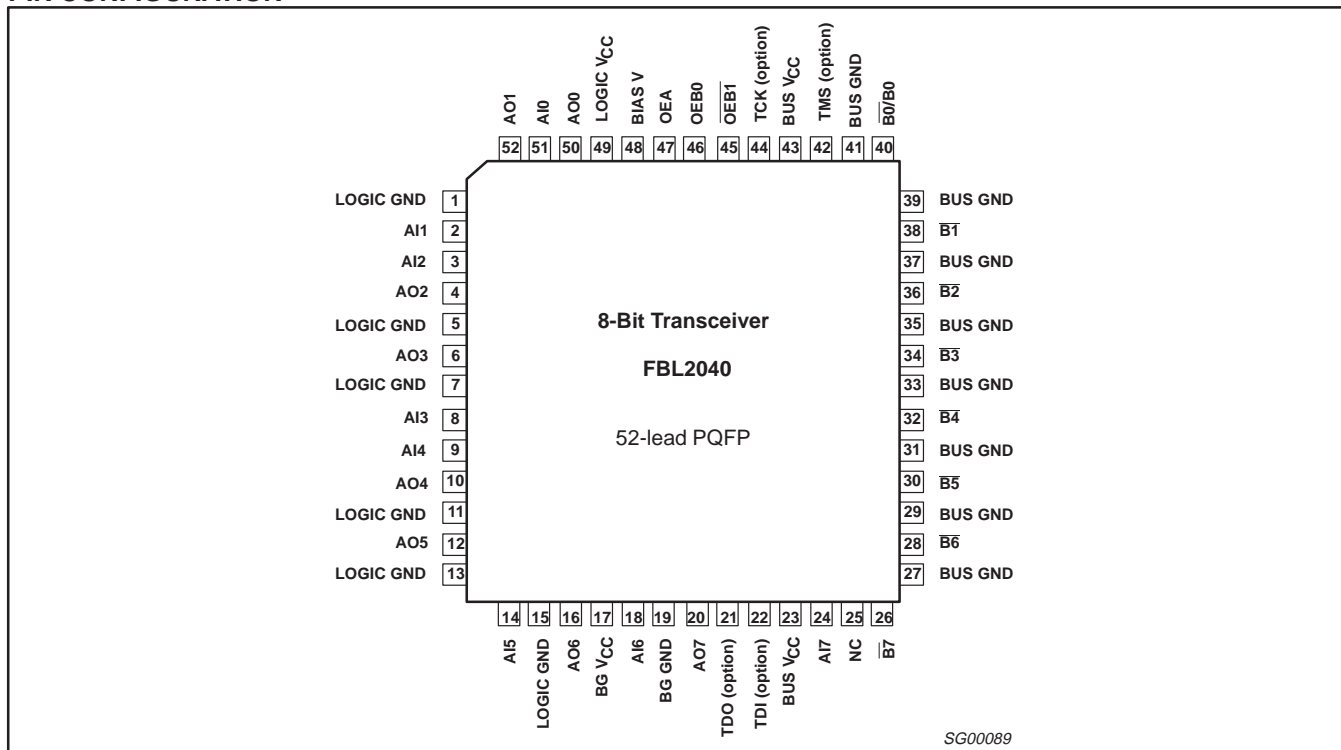

DESCRIPTION

The FBL2040 is an 8-bit bidirectional BTL transceiver and is intended to provide the electrical interface to a high performance wired-OR bus. The FBL2040 is an inverting transceiver.

The B-port drivers are Low-capacitance open collectors with controlled ramp and are designed to sink 100mA. Precision band gap references on the B-port insure very good noise margins by limiting the switching threshold to a narrow region centered at 1.55V.

The B-port interfaces to "Backplane Transceiver Logic" (See the IEEE 1194.1 BTL standard). BTL features low power consumption by reducing voltage swing (1Vp-p, between 1V and 2V) and reduced capacitive loading by placing an internal series diode on the drivers. BTL also provides incident wave switching, a necessity for high performance backplanes.

The A-port operates at TTL levels with separate I/O. The 3-state A-port drivers are enabled when OEA goes High after an extra 6ns delay which is built in to provide a break-before-make function. When OEA goes Low, A-port drivers become High impedance without any extra delay. During power on/off cycles, the A-port drivers are held in a High impedance state when VCC is below 1.3V.

The B-port has two output enables, OEB0 and $\overline{OEB1}$. When OEB0 is High and $\overline{OEB1}$ is Low the output is enabled. When OEB0 is Low

or if $\overline{OEB1}$ is High, the B-port is inactive and is at the level of the backplane signal.

To support live insertion, OEB0 is held Low during power on/off cycles to insure glitch free B port drivers. Proper bias for B port drivers during live insertion is provided by the BIAS V pin when at a 3.3V level while VCC is Low. If live insertion is not a requirement, the BIAS V pin should be tied to a VCC pin.

The LOGIC GND and BUS GND pins are isolated in the package to minimize noise coupling between the BTL and TTL sides. These pins should be tied to a common ground external to the package.

Each BTL driver has an associated BUS GND pin that acts as a signal return path and these BUS GND pins are internally isolated from each other. In the event of a ground return fault, a "hard" signal failure occurs instead of a pattern dependent error that may be very infrequent and impossible to trouble-shoot.

The LOGIC VCC and BUS VCC pins are also isolated internally to minimize noise and may be externally decoupled separately or simply tied together.

JTAG boundary scan pins are provided with signals TMS, TCK, TDI and TDO. TMS and TCK are no-connects (no bond wires) and TDI and TDO are shorted together internally. Boundary scan functionality is not implemented at this time.

3.3V BTL 8-bit TTL to BTL transceiver

FBL2040

PIN DESCRIPTION

SYMBOL	PIN NUMBER	TYPE	NAME AND FUNCTION
AI0 – AI7	51, 2, 3, 8, 9, 14, 18, 24	Input	Data inputs (TTL)
AO0 – AO7	50, 52, 4, 6, 10, 12, 16, 20	Output	3-state outputs (TTL)
$\overline{B}0$ – $\overline{B}7$	40, 38, 36, 34, 32, 30, 28, 26	I/O	Data inputs/Open Collector outputs. High current drive (BTL)
OEB0	46	Input	Enables the B outputs when High
$\overline{OEB}1$	45	Input	Enables the B outputs when Low
OEA	47	Input	Enables the A outputs when High
BUS GND	41, 39, 37, 35, 33, 31, 29, 27	GND	Bus ground (0V)
LOGIC GND	1, 5, 7, 11, 13, 15	GND	Logic ground (0V)
BUS V _{CC}	23, 43	Power	Positive supply voltage
LOGIC V _{CC}	49	Power	Positive supply voltage
BG V _{CC}	17	Power	Band Gap threshold voltage reference
BG GND	19	GND	Band Gap threshold voltage reference ground
BIAS V	48	Power	Live insertion pre-bias pin
TMS	42	Input	Test Mode Select (optional, if not implemented then no-connect)
TCK	44	Input	Test Clock (optional, if not implemented then no-connect)
TDI	22	Input	Test Data In (optional, if not implemented then shorted to TDO)
TDO	21	Output	Test Data Out (optional, if not implemented then shorted to TDI)
NC	25	NC	No Connect

FUNCTION TABLE

MODE	INPUTS					OUTPUTS	
	A _{In}	\overline{B}_n^*	OEB0	$\overline{OEB}1$	OEA	A _{On}	\overline{B}_n^*
A _{In} to \overline{B}_n	L	—	H	L	L	Z	H**
	H	—	H	L	L	Z	L
	L	—	H	L	H	L	H**
	H	—	H	L	H	H	L
Disable \overline{B}_n outputs	X	X	L	X	X	X	H**
	X	X	X	H	X	X	H**
\overline{B}_n to A _{On}	X	L	L	X	H	H	Input
	X	H	X	H	H	L	Input
	X	L	X	H	H	H	Input
	X	H	L	X	H	L	Input
Disable A _{On} outputs	—	X	X	X	L	Z	X

H** = Goes to level of pull-up voltage

B* = Precaution should be taken to ensure B inputs do not float. If they do, they are equal to Low state.

3.3V BTL 8-bit TTL to BTL transceiver

FBL2040

RECOMMENDED OPERATING CONDITIONS

SYMBOL	PARAMETER		LIMITS			UNIT
			MIN	NOM	MAX	
V_{CC}	Supply voltage		3.0	3.3	3.6	V
V_{IH}	High-level input voltage	Except $\overline{B0}$ – $\overline{B7}$	2.0			V
		$B0$ – $B7$	1.62	1.55		
V_{IL}	Low-level input voltage	Except $\overline{B0}$ – $\overline{B7}$			0.8	V
		$B0$ – $B7$			1.47	
I_{IK}	Input clamp current				-18	mA
I_{OH}	High-level output current	$A00$ – $A07$			-32	mA
I_{OL}	Low-level output current	$A00$ – $A07$			32	mA
		$\overline{B0}$ – $\overline{B7}$			100	
C_{OB}	Output capacitance on B port			6	7	pF
T_{amb}	Operating free-air temperature range		-40		+85	°C

LIVE INSERTION SPECIFICATIONS

SYMBOL	PARAMETER		LIMITS			UNIT
			MIN	TYP	MAX	
V_{BIASV}	Bias pin voltage	Voltage difference between the Bias voltage and V_{CC} after the PCB is plugged in.	–	–	0.5	V
I_{BIASV}	Bias pin (I_{BIASV}) input DC current	$V_{CC} = 0$ V, Bias $V = 3.6$ V			1.2	mA
		$V_{CC} = 3.3$ V, Bias $V = 3.6$ V			10	μ A
V_{Bn}	Bus voltage during prebias	$\overline{B0}$ – $\overline{B8} = 0$ V, Bias $V = 3.3$ V	1.62		2.1	V
I_{LM}	Fall current during prebias	$\overline{B0}$ – $\overline{B8} = 2$ V, Bias $V = 1.3$ to 2.5 V			1	μ A
I_{HM}	Rise current during prebias	$\overline{B0}$ – $\overline{B8} = 1$ V, Bias $V = 3$ to 3.6 V	-1			μ A
I_{Bn}^{PEAK}	Peak bus current during insertion	$V_{CC} = 0$ to 3.3 V, $\overline{B0}$ – $\overline{B8} = 0$ to 2.0 V, Bias $V = 2.7$ to 3.6 V, $OEB0 = 0.8$ V, $t_r = 2$ ns			10	mA
I_{OLOFF}	Power up current	$V_{CC} = 0$ to 3.3 V, $OEB0 = 0.8$ V			100	μ A
		$V_{CC} = 0$ to 1.2 V, $OEB0 = 0$ to 5 V			100	
t_{GR}	Input glitch rejection	$V_{CC} = 3.3$ V	1.0	1.35		ns

3.3V BTL 8-bit TTL to BTL transceiver

FBL2040

LOGIC DIAGRAM FOR FBL2040

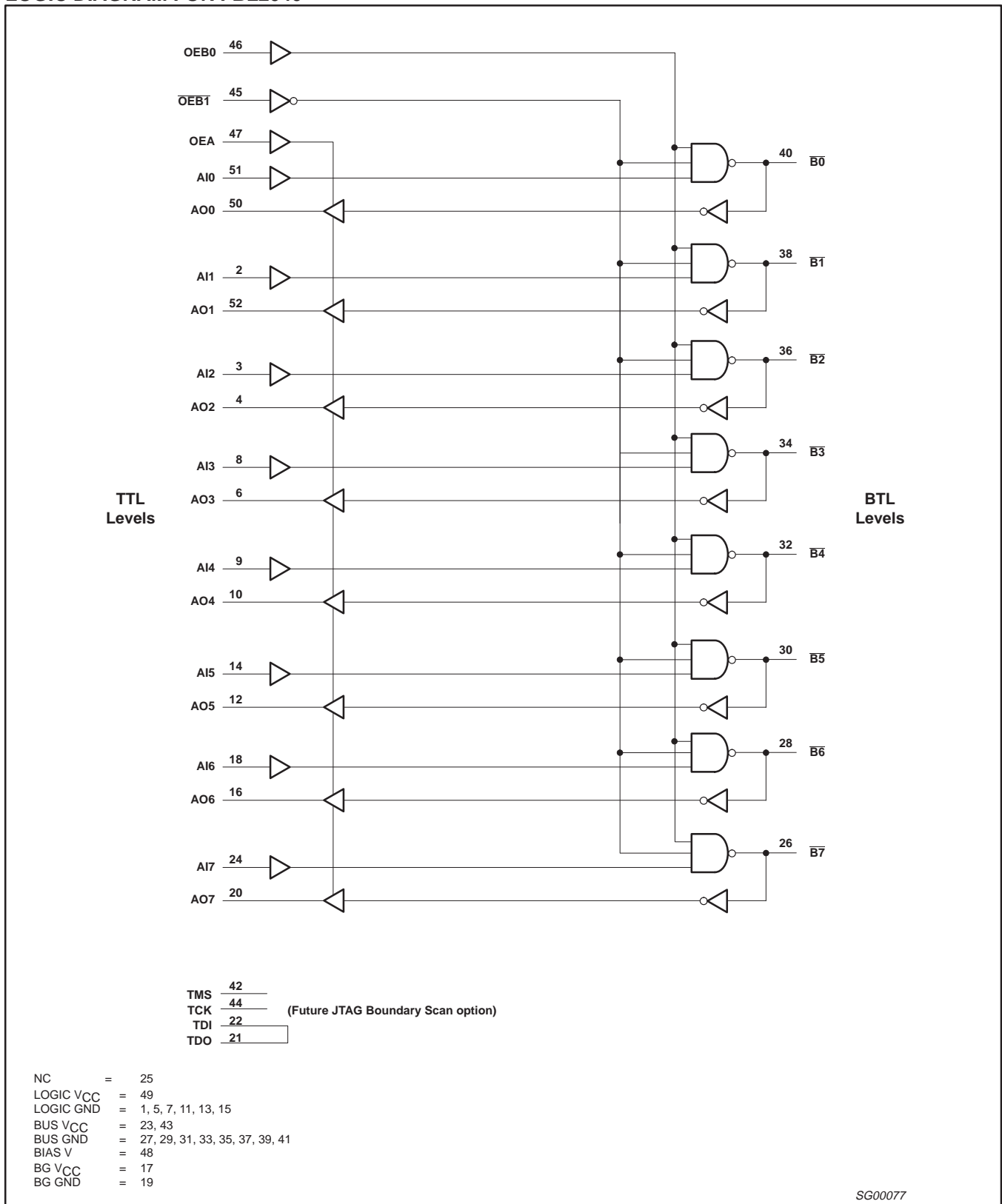

3.3V BTL 8-bit TTL to BTL transceiver

FBL2040

DC ELECTRICAL CHARACTERISTICS

Over recommended operating free-air temperature range unless otherwise noted.

symbol	parameter		test conditions ¹	limits			unit	
				min	typ ²	max		
I _{OH}	High level output current	B $\bar{0}$ – B $\bar{7}$	V _{CC} = MAX, V _{IL} = MAX, V _{OH} = 1.9V			100	μA	
I _{OFF}	Power-off output current	B $\bar{0}$ – B $\bar{7}$	V _{CC} = 0V, V _{IL} = MAX, V _{OH} = 1.9V			100	μA	
			V _{CC} = 0V, V _{IL} = MAX, V _{OH} = 1.9V @ 85°C			300		
V _{OH}	High-level output voltage	AO0 – AO7 ³	V _{CC} = MIN to MAX; I _{OH} = -100μA	V _{CC}			V	
			V _{CC} = MIN; I _{OH} = -8mA	-0.2			V	
			V _{CC} = MIN; I _{OH} = -32mA	2.4			V	
V _{OL}	Low-level output voltage	AO0 – AO7 ³	V _{CC} = MIN; I _{OL} = 16mA			0.4	V	
			V _{CC} = MIN; I _{OL} = 32mA			0.5	V	
		B $\bar{0}$ – B $\bar{7}$	V _{CC} = MIN, I _{OL} = 4mA	0.5			V	
			V _{CC} = MIN, I _{OL} = 100mA	0.75	1.0	1.20		
V _{IK}	Input clamp voltage		V _{CC} = MIN, I _I = I _{IK} = -18mA		-0.85	-1.2	V	
I _I	Input leakage current	Control pins	V _{CC} = 3.6V; V _I = V _{CC} or 100mV			±1.0	μA	
		Control/ AI0 – AI7	V _{CC} = 0V or 3.6V; V _I = 5.5V			10		
		AI0 – AI7 Note 4	V _{CC} = 3.6V; V _I = V _{CC} V _{CC} = 3.6V; V _I = 100mV			1 -5		
I _{IH}	High-level input current	B $\bar{0}$ – B $\bar{7}$	V _{CC} = MAX, V _I = 1.9V			100	μA	
			V _{CC} = MAX, V _I = 3.5V, note 5	100				mA
			V _{CC} = MAX, V _I = 3.75V, Note 5 @ -40°C	100				
I _{IL}	Low-level input current	B $\bar{0}$ – B $\bar{7}$	V _{CC} = MAX, V _I = 0.75V			-100	μA	
I _{OZH}	Off-state output current	AO0 – AO7	V _{CC} = MAX, V _O = 3V			5	μA	
I _{OZL}	Off-state output current	AO0 – AO7	V _{CC} = MAX, V _O = 0.5V			-5	μA	
I _{CCZ}	Supply current		V _{CC} = MAX, outputs disabled, V _I = GND or 0.0		16	31	mA	
I _{CCH} I _{CCL}	Supply current (total)	B → A	V _{CC} = MAX, outputs High, V _I = GND or 0.0		16	35		
			V _{CC} = MAX, outputs Low, V _I = GND or 0.0		18	39		
I _{CCH} I _{CCL}	Supply current (total)	A → B	V _{CC} = MAX, outputs High, V _I = GND or 0.0		13	30		
			V _{CC} = MAX, outputs Low, V _I = GND or 0.0		8	16		

NOTES:

- For conditions shown as MIN or MAX, use the appropriate value specified under recommended operation conditions for the applicable type.
- All typical values are at V_{CC} = 3.3V, T_A = 25°C.
- Due to test equipment limitations, actual test conditions are V_{IH} = 1.8V and V_{IL} = 1.3V for the B side.
- Unused pins are at V_{CC} or GND.
- For B port input voltage between 3 and 5 volt; I_{IH} will be greater than 100mA but the part will continue to function normally (clamping circuit is Active). This is not a tested condition.

3.3V BTL 8-bit TTL to BTL transceiver

FBL2040

AC ELECTRICAL CHARACTERISTICS INDUSTRIAL AND COMMERCIAL (A TO B)

SYMBOL	PARAMETER	TEST CONDITION	$T_{amb} = +25^{\circ}\text{C}, V_{CC} = 3.3\text{V}, R_L = 9\Omega$			$T_{amb} = -40 \text{ to } +85^{\circ}\text{C}, V_{CC} = 3.3\text{V} \pm 10\%, R_L = 9\Omega$		UNIT
			MIN	TYP	MAX	MIN	MAX	
t_{PLH} t_{PHL}	Propagation delay, AIn to $\bar{B}n$		1.0 1.2	2.7 3.0	5.7 5.1	1.0 1.0	6.3 5.6	ns
t_{PLH} t_{PHL}	OEB0 to $\bar{B}n$		1.4 2.0	3.1 4.1	5.0 6.4	1.0 1.9	6.1 6.9	ns
t_{PLH} t_{PHL}	$\overline{\text{OEB}}\bar{1}$ to $\bar{B}n$		1.5 1.4	3.3 3.2	5.3 5.0	1.0 1.1	6.0 5.8	ns
t_{TLH} t_{THL}	Transition time, $\bar{B}n$ Port (1.3V to 1.8V)		1.0 1.2	1.7 1.9	2.5 2.5	0.5 0.5	3.0 3.0	ns
$t_{sk}(O)$	Output skew between receivers in same package		0.5	1.0			1.5	ns
$t_{sk}(P)$	Pulse skew $ t_{PHL} - t_{PLH} $ MAX		0.3	1.0			1.5	ns

AC ELECTRICAL CHARACTERISTICS INDUSTRIAL AND COMMERCIAL (A TO B)

SYMBOL	PARAMETER	TEST CONDITION	$T_{amb} = +25^{\circ}\text{C}, V_{CC} = 3.3\text{V}, R_L = 16.5\Omega$			$T_{amb} = -40 \text{ to } +85^{\circ}\text{C}, V_{CC} = 3.3\text{V} \pm 10\%, R_L = 16.5\Omega$		UNIT
			MIN	TYP	MAX	MIN	MAX	
t_{PLH} t_{PHL}	Propagation delay, AIn to $\bar{B}n$		1.2 1.2	2.8 2.8	4.4 4.6	1.0 1.1	5.2 5.1	ns
t_{PLH} t_{PHL}	OEB0 to $\bar{B}n$		1.8 1.8	3.6 3.8	5.6 5.9	1.2 1.7	6.5 6.3	ns
t_{PLH} t_{PHL}	$\overline{\text{OEB}}\bar{1}$ to $\bar{B}n$		1.6 1.3	3.4 3.0	6.2 4.8	1.0 1.0	6.0 5.6	ns
t_{TLH} t_{THL}	Transition time, $\bar{B}n$ Port (1.3V to 1.8V)		1.0 1.2	1.7 1.9	2.5 2.5	0.5 0.5	3.0 3.0	ns
$t_{sk}(O)$	Output skew between receivers in same package		0.5	1.0			1.5	ns
$t_{sk}(P)$	Pulse skew $ t_{PHL} - t_{PLH} $ MAX		0.3	1.0			1.5	ns

AC ELECTRICAL CHARACTERISTICS INDUSTRIAL AND COMMERCIAL (B TO A)

SYMBOL	PARAMETER	TEST CONDITION	$T_{amb} = +25^{\circ}\text{C}, V_{CC} = 3.3\text{V}$			$T_{amb} = -40 \text{ to } +85^{\circ}\text{C}, V_{CC} = 3.3\text{V} \pm 10\%$		UNIT
			MIN	TYP	MAX	MIN	MAX	
t_{PLH} t_{PHL}	Propagation delay, $\bar{B}n$ to AOn		1.5 1.7	3.4 3.6	5.4 5.5	1.3 1.5	6.1 6.8	ns
t_{PLH} t_{PHL}	OEA to AOn		2.1 2.0	4.0 3.7	5.9 5.5	1.9 1.4	6.5 6.5	ns
t_{PLH} t_{PHL}	OEA to AOn		2.0 1.0	1.8 1.0	5.9 4.3	1.8 1.0	6.2 4.8	ns
t_{TLH} t_{THL}	Transition time, AOn Port (10% to 90% or 90% to 10%)		1.3 1.7	2.2 2.6	2.5 2.5	0.9 0.8	3.0 3.0	ns
$t_{sk}(O)$	Output skew between receivers in same package		0.5	1.0			1.5	ns
$t_{sk}(P)$	Pulse skew $ t_{PHL} - t_{PLH} $ MAX		0.3	1.0			1.5	ns

3.3V BTL 8-bit TTL to BTL transceiver

FBL2040

AC WAVEFORMS

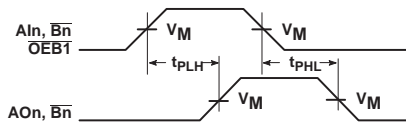

Waveform 1. Propagation Delay for Data or Output Enable to Output

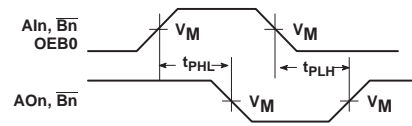

Waveform 2. Propagation Delay for Data or Output Enable to Output

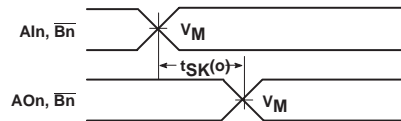

Waveform 3. Output Skews

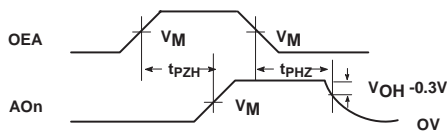

Waveform 4. 3-State Output Enable Time to High Level and Output Disable Time from High Level

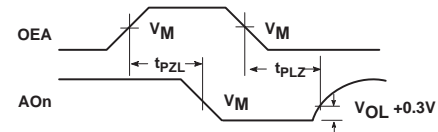

Waveform 5. 3-State Output Enable Time to Low Level and Output Disable Time from Low Level

NOTE: $V_M = 1.55V$ for \overline{Bn} , $V_M = 1.5V$ for all others.

SG00078

3.3V BTL 8-bit TTL to BTL transceiver

FBL2040

TEST CIRCUIT AND WAVEFORMS

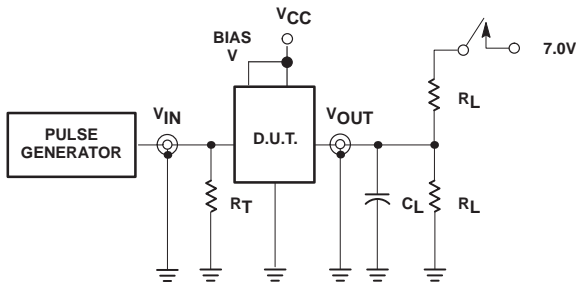

Test Circuit for 3-State Outputs on A Port

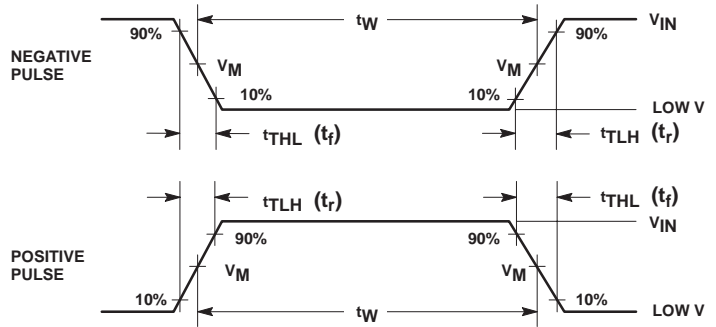

$V_M = 1.55V$ for \overline{Bn} , $V_M = 1.5V$ for all others.

Input Pulse Definitions

SWITCH POSITION

TEST	SWITCH
t_{PLZ} , t_{PZL}	closed
All other	open

Family FB+	INPUT PULSE REQUIREMENTS					
	Amplitude	Low V	Rep. Rate	t_W	t_{TLH}	t_{THL}
A Port	3.0V	0.0V	1MHz	500ns	2.5ns	2.5ns
B Port	2.0V	1.0V	1MHz	500ns	2.5ns	2.5ns

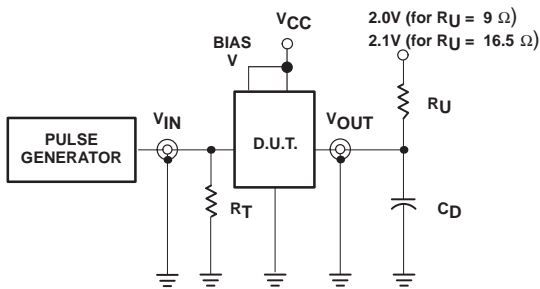

Test Circuit for Outputs on B Port

DEFINITIONS:

- R_L = Load Resistor; see AC CHARACTERISTICS for value.
- C_L = Load capacitance includes jig and probe capacitance; see AC CHARACTERISTICS for value.
- R_T = Termination resistance should be equal to Z_{OUT} of pulse generators.
- C_D = Load capacitance includes jig and probe capacitance; see AC CHARACTERISTICS for value.
- R_U = Pull up resistor; see AC CHARACTERISTICS for value.

SG00059

3.3V BTL 8-bit TTL TO BTL transceiver

74FBL2040

QFP52: plastic quad flat package; 52 leads (lead length 1.6 mm); body 10 x 10 x 2.0 mm

SOT379-1

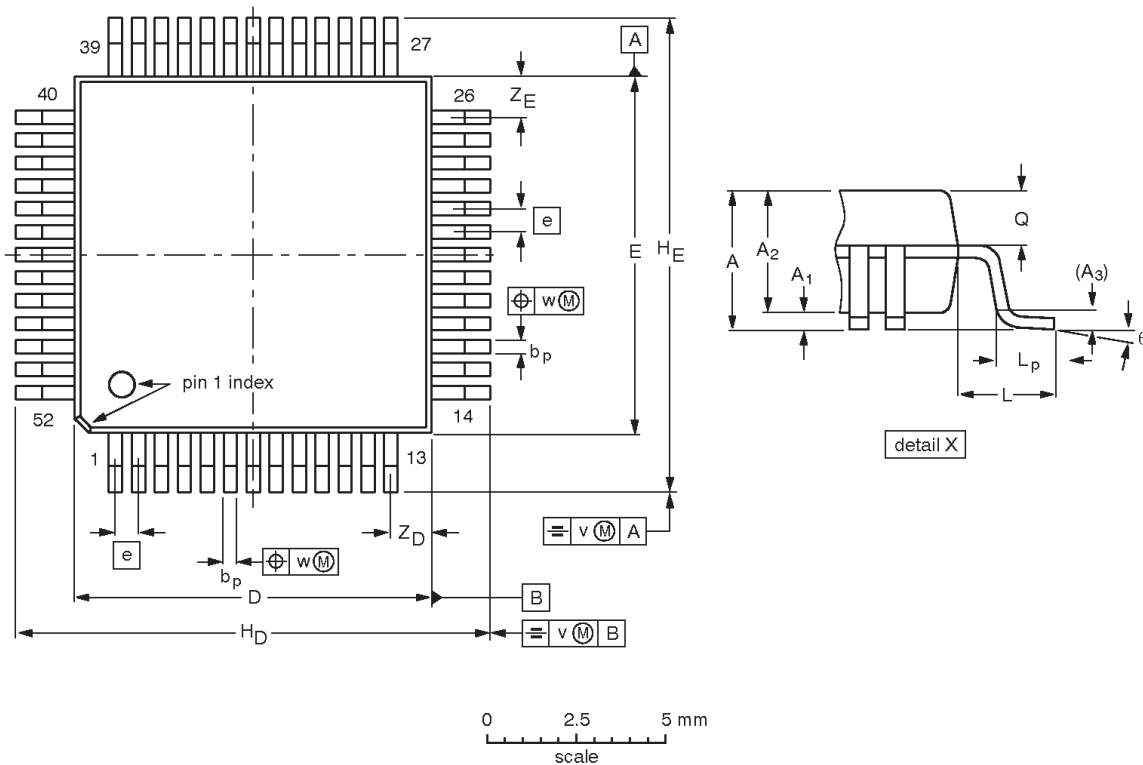
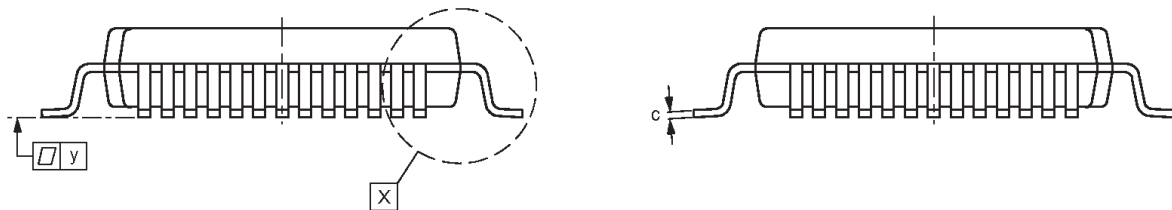

DIMENSIONS (mm are the original dimensions)

UNIT	A max.	A ₁	A ₂	A ₃	b _p	c	D ⁽¹⁾	E ⁽¹⁾	e	H _D	H _E	L	L _p	Q	v	w	y	Z _D ⁽¹⁾	Z _E ⁽¹⁾	θ
mm	2.45	0.45 0.25	2.10 1.95	0.25	0.38 0.22	0.23 0.13	10.1 9.9	10.1 9.9	0.65	13.45 12.95	13.45 12.95	1.60	0.95 0.65	1.05 0.90	0.20	0.12	0.10	1.24 0.95	1.24 0.95	7° 0°

Note

1. Plastic or metal protrusions of 0.25 mm maximum per side are not included.

OUTLINE VERSION	REFERENCES				EUROPEAN PROJECTION	ISSUE DATE
	IEC	JEDEC	EIAJ			
SOT379-1		MO-108				95-02-04

3.3V BTL 8-bit TTL TO BTL transceiver

74FBL2040

Data sheet status

Data sheet status	Product status	Definition [1]
Objective specification	Development	This data sheet contains the design target or goal specifications for product development. Specification may change in any manner without notice.
Preliminary specification	Qualification	This data sheet contains preliminary data, and supplementary data will be published at a later date. Philips Semiconductors reserves the right to make changes at any time without notice in order to improve design and supply the best possible product.
Product specification	Production	This data sheet contains final specifications. Philips Semiconductors reserves the right to make changes at any time without notice in order to improve design and supply the best possible product.

[1] Please consult the most recently issued datasheet before initiating or completing a design.

Definitions

Short-form specification — The data in a short-form specification is extracted from a full data sheet with the same type number and title. For detailed information see the relevant data sheet or data handbook.

Limiting values definition — Limiting values given are in accordance with the Absolute Maximum Rating System (IEC 134). Stress above one or more of the limiting values may cause permanent damage to the device. These are stress ratings only and operation of the device at these or at any other conditions above those given in the Characteristics sections of the specification is not implied. Exposure to limiting values for extended periods may affect device reliability.

Application information — Applications that are described herein for any of these products are for illustrative purposes only. Philips Semiconductors make no representation or warranty that such applications will be suitable for the specified use without further testing or modification.

Disclaimers

Life support — These products are not designed for use in life support appliances, devices or systems where malfunction of these products can reasonably be expected to result in personal injury. Philips Semiconductors customers using or selling these products for use in such applications do so at their own risk and agree to fully indemnify Philips Semiconductors for any damages resulting from such application.

Right to make changes — Philips Semiconductors reserves the right to make changes, without notice, in the products, including circuits, standard cells, and/or software, described or contained herein in order to improve design and/or performance. Philips Semiconductors assumes no responsibility or liability for the use of any of these products, conveys no license or title under any patent, copyright, or mask work right to these products, and makes no representations or warranties that these products are free from patent, copyright, or mask work right infringement, unless otherwise specified.

Philips Semiconductors
811 East Arques Avenue
P.O. Box 3409
Sunnyvale, California 94088-3409
Telephone 800-234-7381

© Copyright Philips Electronics North America Corporation 1998
All rights reserved. Printed in U.S.A.

print code

Date of release: 05-96

Document order number:

9397-750-04973

Let's make things better.